

64K x 1 Bit Dynamic RAM with Page Mode

FEATURES

• Performance range

	t _{RAC}	t _{CAC}	t _{RC}
KM4164B-10	100ns	55ns	190ns
KM4164B-12	120ns	60ns	220ns
KM4164B-15	150ns	75ns	260ns

- Page Mode capability
- Single +5V ±10% power supply
- Common I/O using early write
- TTL compatible inputs and output
- Schmitt Triggers on all input control lines
- RAS-only and Hidden Refresh capability
- 128 cycle/2ms refresh
- JEDEC standard pinout in 16-pin DIP

GENERAL DESCRIPTION

The KM4164B is a fully decoded NMOS Dynamic Random Access Memory organized as 65,536 one-bit words. The design is optimized for high speed, high performance applications such as computer memory, peripheral storage and environments where low power dissipation and compact layout are required.

The KM4164B features page mode which allows high speed random access of up to 256-bits within the same row. Multiplexed row and column address inputs permit the KM4164B to be housed in a standard 16-pin DIP.

The KM4164B is fabricated using Samsung's advanced silicon gate NMOS process. This process, coupled with single transistor memory storage cells, permits maximum circuit density and minimal chip size.

Clock timing requirements are noncritical, and power supply tolerance is very wide. All inputs and output are TTL compatible.

FUNCTIONAL BLOCK DIAGRAM

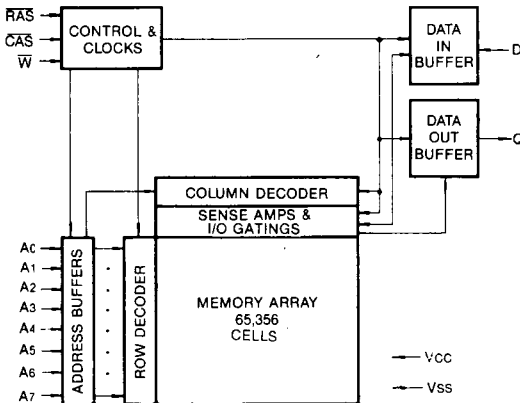

PIN CONFIGURATION (Top Views)

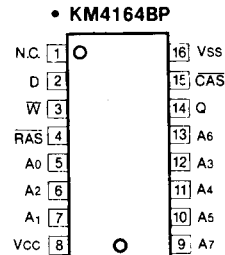

Pin Name	Pin Function
A ₀ -A ₇	Address inputs
D	Data In
Q	Data Out
\bar{W}	Read/Write Input
\bar{RAS}	Row Address Strobe
\bar{CAS}	Column Address Strobe
V _{CC}	Power (+ 5V)
V _{SS}	Ground

ABSOLUTE MAXIMUM RATINGS*

Parameter	Symbol	Rating	Units
Voltage on any pin relative to V_{SS}	V_{IN}, V_{OUT}	- 2.0 to + 7.0	V
Voltage on V_{CC} supply relative to V_{SS}	V_{CC}	- 1 to + 7.5	V
Storage Temperature	T_{stg}	- 65 to + 150	°C
Power Dissipation	P_D	1.0	W
Short Circuit Output Current	I_{OS}	50	mA

* Permanent device damage may occur if "ABSOLUTE MAXIMUM RATINGS" are exceeded. Functional operation should be restricted to the conditions as detailed in the operational sections of this data sheet. Exposure to absolute maximum rating conditions for extended periods may affect device reliability.

RECOMMENDED OPERATING CONDITIONS (Voltages referenced to V_{SS} , $T_A = 0$ to 70°C)

Parameter	Symbol	Min	Typ	Max	Unit
Supply Voltage	V_{CC}	4.5	5.0	5.5	V
Ground	V_{SS}	0	0	0	V
Input High Voltage	V_{IH}	2.4	—	$V_{CC} + 1$	V
Input Low Voltage	V_{IL}	- 2.0	—	0.8	V

DC AND OPERATING CHARACTERISTICS

(Recommended operating conditions unless otherwise noted.)

Parameter	Symbol	Min	Max	Units
Operating Current* (RAS and CAS cycling; @ $t_{RC} = \text{min.}$)	KM4164B-10	—	60	mA
	KM4164B-12	—	50	mA
	KM4164B-15	—	45	mA
Standby Current (RAS = CAS = V_{IH} after 8 $\overline{\text{RAS}}$ cycles min.)	I_{CC2}	—	4	mA
$\overline{\text{RAS}}$ -Only Refresh Current* (CAS = V_{IH} , $\overline{\text{RAS}}$ cycling; @ $t_{RC} = \text{min.}$)	KM4164B-10	—	50	mA
	KM4164B-12	—	40	mA
	KM4164B-15	—	35	mA
Page Mode Current* ($\overline{\text{RAS}} = V_{IL}$, CAS cycling; @ $t_{PC} = \text{min.}$)	KM4164B-10	—	45	mA
	KM4164B-12	—	35	mA
	KM4164B-15	—	30	mA
Input Leakage Current (Any input $0 \leq V_{IN} \leq 5.5\text{V}$, $V_{CC} = 5.5\text{V}$, $V_{SS} = 0\text{V}$, all other pins not under test = 0 volts.)	I_{IL}	- 10	10	μA
Output Leakage Current (Data out is disabled, $0 \leq V_{OUT} \leq 5.5\text{V}$, $V_{CC} = 5.5\text{V}$, $V_{SS} = 0\text{V}$)	I_{OL}	- 10	10	μA
Output High Voltage Level ($I_{OH} = -5\text{mA}$)	V_{OH}	2.4	—	V
Output Low Voltage Level ($I_{OL} = 4.2\text{mA}$)	V_{OL}	—	0.4	V

*Note: I_{CC} is dependent on output loading and cycle rates. Specified values are obtained with the output open. I_{CC} is specified as an average current.

CAPACITANCE ($T_A = 25^\circ\text{C}$)

Parameter	Symbol	Min	Max	Unit
Input capacitance (A_0 - A_7 , D)	C_{IN1}	—	5	pF
Input capacitance ($\overline{\text{RAS}}$, $\overline{\text{CAS}}$, W)	C_{IN2}	—	7	pF
Output Capacitance (Q)	C_{OUT}	—	6	pF

AC CHARACTERISTICS ($0^\circ\text{C} \leq T_A \leq 70^\circ\text{C}$, $V_{CC} = 5.0\text{V} \pm 10\%$. See notes 1,2.)

Parameter	Symbol	KM4164B-10		KM4164B-12		KM4164B-15		Unit	Notes
		Min	Max	Min	Max	Min	Max		
Random read or write cycle time	t_{RC}	190		220		260		ns	
Read-modify-write cycle time	t_{RWC}	215		255		300		ns	
Access time from $\overline{\text{RAS}}$	t_{RAC}		100		120		150	ns	3, 4
Access time from $\overline{\text{CAS}}$	t_{CAC}		55		60		75	ns	3, 5
Output buffer turn-off delay time	t_{OFF}	0	25	0	30	0	35	ns	6
Transition time (rise and fall)	t_T	3	100	3	100	3	100	ns	
$\overline{\text{RAS}}$ precharge time	t_{RP}	80		90		100		ns	
$\overline{\text{RAS}}$ pulse width	t_{RAS}	100	10,000	120	10,000	150	10,000	ns	
$\overline{\text{RAS}}$ hold time	t_{RSH}	55		60		75		ns	
$\overline{\text{CAS}}$ pulse width	t_{CAS}	55	10,000	60	10,000	75	10,000	ns	
$\overline{\text{CAS}}$ hold time	t_{CSH}	100		120		150		ns	
$\overline{\text{RAS}}$ to $\overline{\text{CAS}}$ delay time	t_{RCD}	15	45	20	60	25	75	ns	4
$\overline{\text{CAS}}$ to $\overline{\text{RAS}}$ precharge time	t_{CRP}	0		0		0		ns	
Row address set-up time	t_{ASR}	0		0		0		ns	
Row address hold time	t_{RAH}	15		18		20		ns	
Column address set-up time	t_{ASC}	0		0		0		ns	
Column address hold time	t_{CAH}	25		30		35		ns	
Column address hold time referenced to $\overline{\text{RAS}}$	t_{AR}	70		90		110		ns	
Read command set-up time	t_{RCS}	0		0		0		ns	
Read command hold time referenced to $\overline{\text{CAS}}$	t_{RCH}	0		0		0		ns	
Read command hold time referenced to $\overline{\text{RAS}}$	t_{RRH}	0		0		0		ns	
Write command set-up time	t_{WCS}	0		0		0		ns	7
Write command hold time	t_{WCH}	30		35		45		ns	
Write command pulse width	t_{WP}	30		35		45		ns	
Write command to $\overline{\text{RAS}}$ lead time	t_{RWL}	25		35		45		ns	
Write command to $\overline{\text{CAS}}$ lead time	t_{CWL}	25		35		45		ns	
Data-in set-up time	t_{DS}	0		0		0		ns	
Data-in hold time	t_{DH}	30		35		40		ns	
$\overline{\text{CAS}}$ to $\overline{\text{W}}$ delay time	t_{CWD}	50		55		65		ns	7

2

AC CHARACTERISTICS (Continued)

Parameter	Symbol	KM4164B-10		KM4164B-12		KM4164B-15		Units	Notes
		Min	Max	Min	Max	Min	Max		
RAS to \bar{W} delay time	t_{RWD}	95		115		140		ns	7
Write command hold time referenced to \bar{RAS}	t_{WCR}	75		95		120		ns	
Data-in hold time referenced to \bar{RAS}	t_{DHR}	75		95		115		ns	
Page mode cycle time	t_{PC}	105		120		145		ns	
CAS precharge time (page mode only)	t_{CP}	40		45		60		ns	
CAS precharge time (all cycles except page mode)	t_{CPN}	25		25		30		ns	
Refresh period (128 cycles)	t_{REF}		2		2		2	ms	

NOTES

1. An initial pause of 100 μ s is required after power-up followed by any 8 \bar{RAS} cycles before proper device operation is achieved.
2. $V_{IH}(\text{min})$ and $V_{IL}(\text{max})$ are reference levels for measuring timing of input signals. Transition times are measured between $V_{IH}(\text{min})$ and $V_{IL}(\text{max})$ and are assumed to be 5ns for all inputs.
3. Measured with a load equivalent to 2 TTL loads and 100pF.
4. Operation within the $t_{RCD}(\text{max})$ limit insures that $t_{RAC}(\text{max})$ can be met, $t_{RCD}(\text{max})$ is specified as a reference point only. If t_{RCD} is greater than the specified $t_{RCD}(\text{max})$ limit, then access time is controlled exclusively by t_{CAC} .
5. Assumes that $t_{RCD} \geq t_{RCD}(\text{max})$.
6. This parameter defines the time at which the output achieves the open circuit condition and is not referenced to V_{OH} or V_{OL} .
7. t_{CWD} and t_{RWD} are restrictive operating parameters for the read-modify-write cycle only. If $t_{WCS} \geq t_{WCS}(\text{min})$, the cycle is an early write cycle and the data output will remain open circuit throughout the entire cycle. If $t_{CWD} \geq t_{CWD}(\text{min})$ and $t_{RWD} > t_{RWD}(\text{min})$, the cycle is a late write cycle and the data output will contain data read from the selected cell. If neither of the above conditions are met, the condition of the data out (at access time until CAS goes back to V_{IH}) is indeterminate.

TIMING DIAGRAMS

READ CYCLE

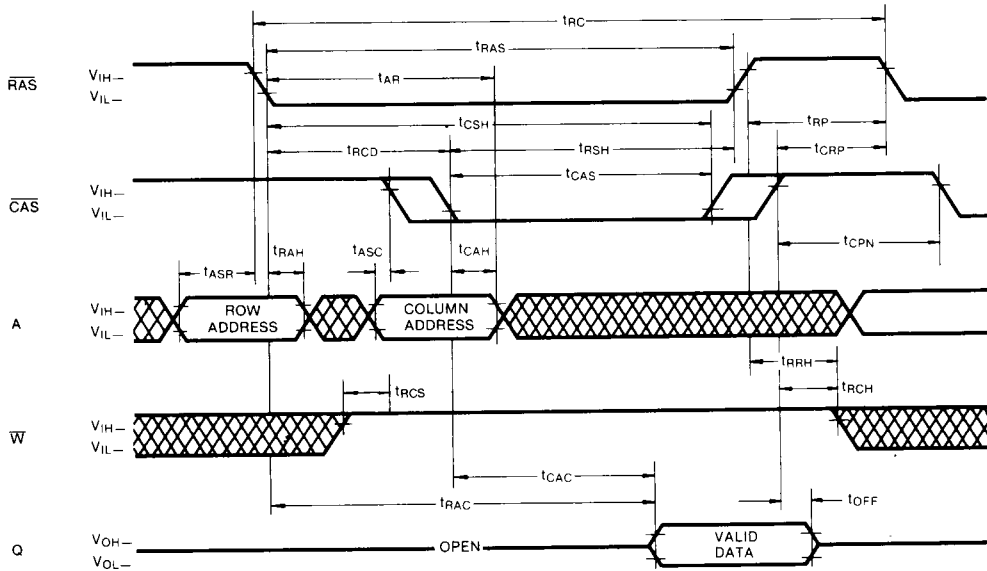

WRITE CYCLE (EARLY WRITE)

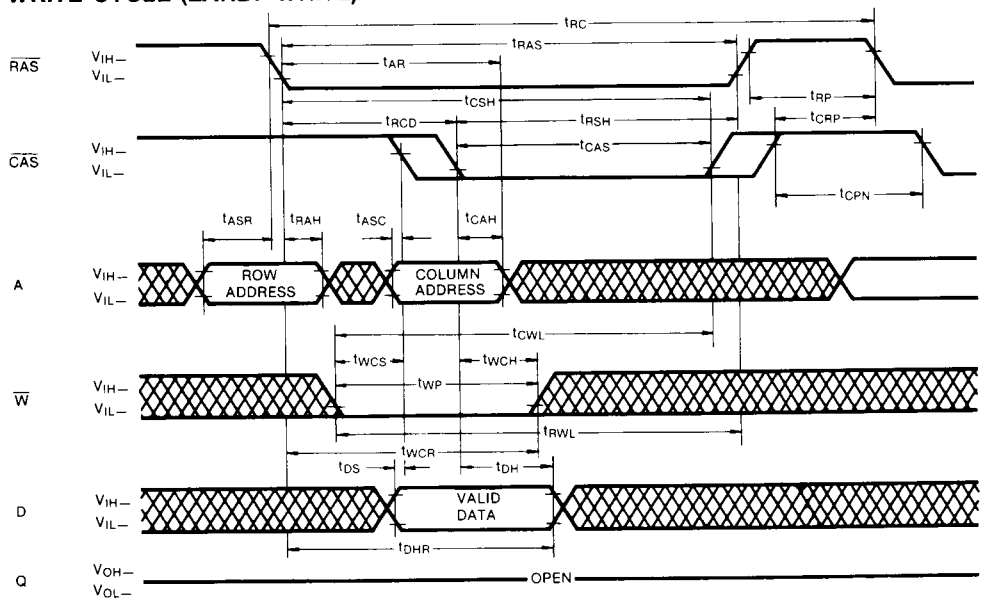

DON'T CARE

2

TIMING DIAGRAMS (Continued)

READ-WRITE/READ-MODIFY-WRITE CYCLE

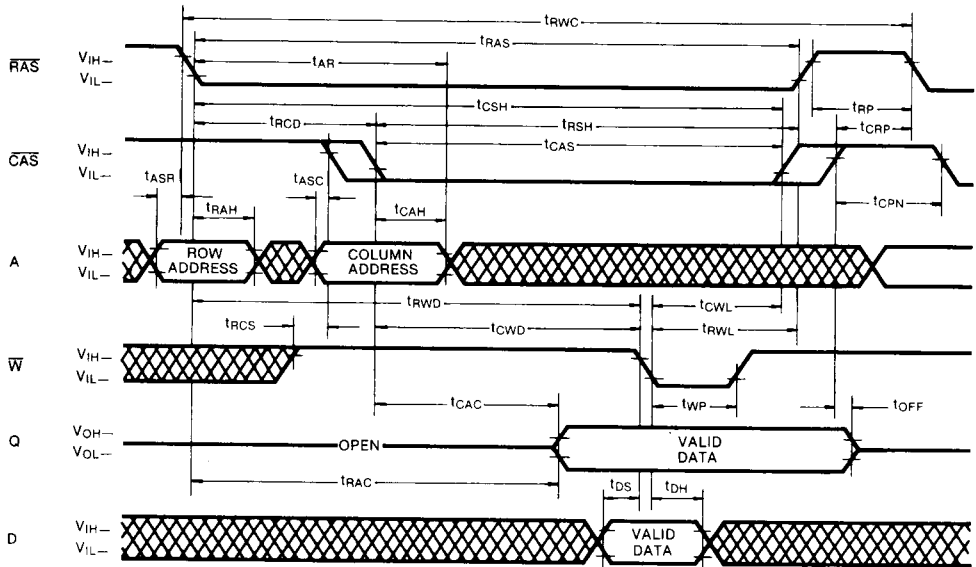

PAGE MODE READ CYCLE

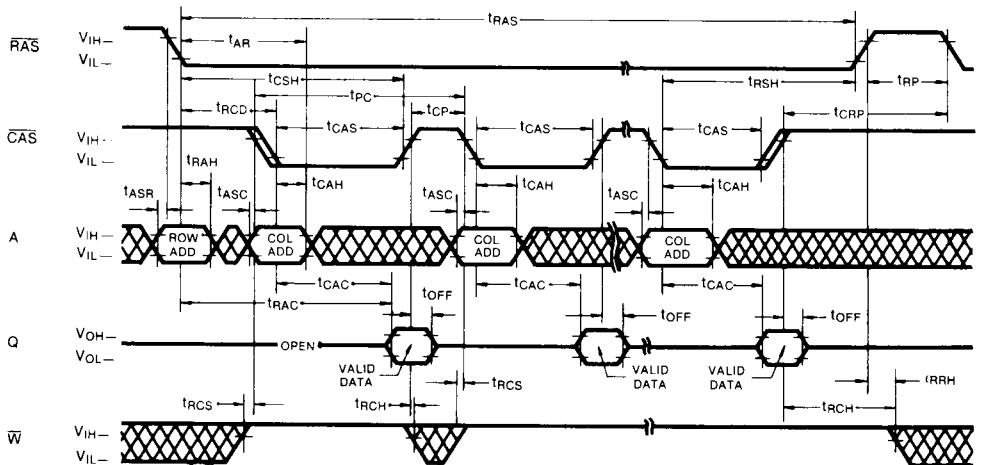

 DON'T CARE

TIMING DIAGRAMS (Continued)

PAGE MODE WRITE CYCLE

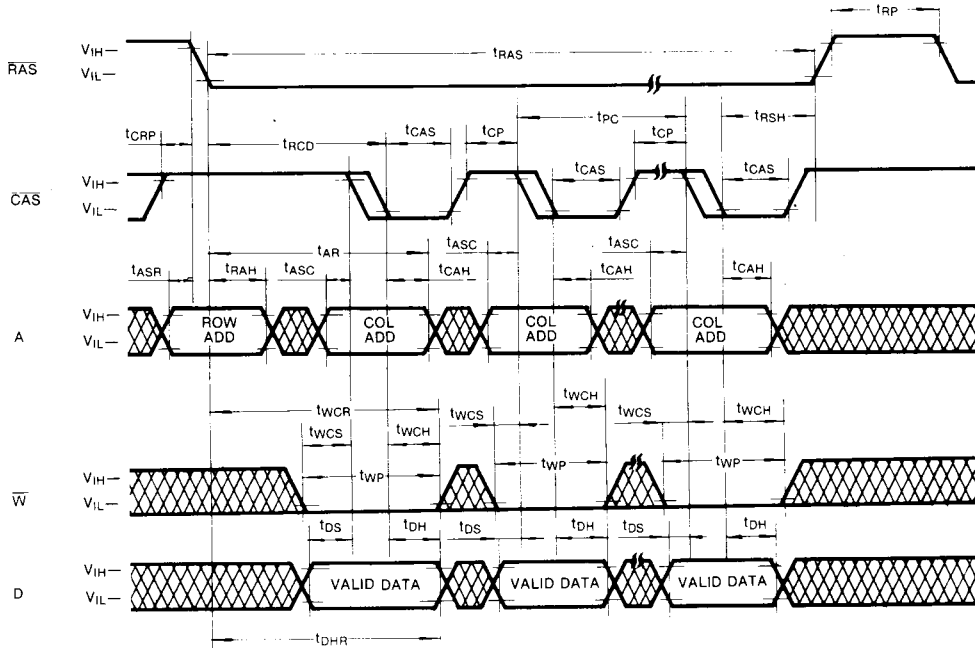

2

RAS-ONLY REFRESH CYCLE

Note: $\overline{CAS} = V_{IH}$, $\overline{W}, D = \text{Don't care}$

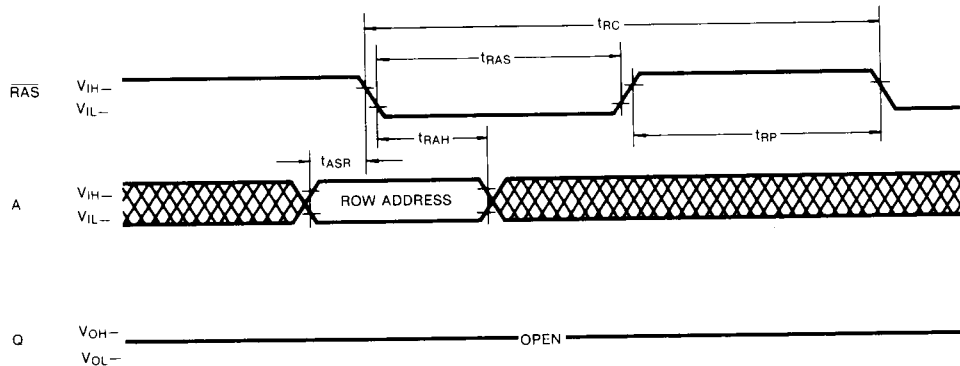

 DON'T CARE

TIMING DIAGRAMS (Continued)

HIDDEN REFRESH CYCLE

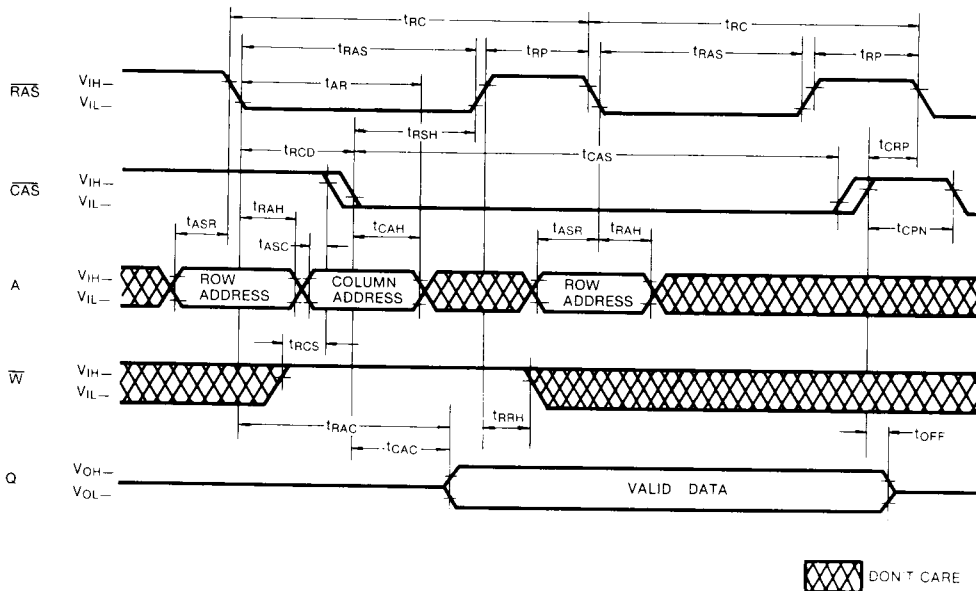

DEVICE OPERATION

Device Operation

The KM4164B contains 65,536 memory locations. Sixteen address bits are required to address a particular memory location. Since the KM4164B has only 8 address input pins, time multiplexed addressing is used to input 8 row and 8 column addresses. The multiplexing is controlled by the timing relationship between the row address strobe (\overline{RAS}), the column address strobe (\overline{CAS}) and the valid address inputs.

Operation of the KM4164B begins by strobing in a valid row address with \overline{RAS} while \overline{CAS} remains high. Then the address on the 8 address input pins is changed from a row address to a column address and is strobed in by \overline{CAS} . This is the beginning of any KM4164B cycle in which a memory location is accessed. The specific type of cycle is determined by the state of the write enable pin and various timing relationships. The cycle is terminated when both \overline{RAS} and \overline{CAS} have returned to the high state. Another cycle can be initiated after \overline{RAS} remains high long enough to satisfy the RAS precharge time (t_{RP}) requirement.

\overline{RAS} and \overline{CAS} Timing

The minimum \overline{RAS} and \overline{CAS} pulse width are specified by $t_{RAS}(\min)$ and $t_{CAS}(\min)$ respectively. These minimum pulse widths must be satisfied for proper device operation and data integrity. Once a cycle is initiated by bringing \overline{RAS} low, it must not be aborted prior to satisfying the minimum \overline{RAS} and \overline{CAS} pulse widths. In addition, a new cycle must not begin until the minimum \overline{RAS} precharge time, t_{RP} , has been satisfied. Once a cycle begins, internal clocks and other circuits within the KM4164B begin a complex sequence of events. If the sequence is broken by violating minimum timing requirements, loss of data integrity can occur.

Read

A read cycle is achieved by maintaining the write enable input (\overline{W}) high during a $\overline{RAS}/\overline{CAS}$ cycle. The output of the KM4164B remains in the Hi-Z state until valid data appears at the output. If \overline{CAS} goes low before $t_{RCD}(\max)$, the access time to valid data is specified by t_{RAC} . If \overline{CAS} goes low after $t_{RCD}(\max)$, the access time is measured

DEVICE OPERATION (Continued)

from $\overline{\text{CAS}}$ and is specified by t_{CAC} . In order to achieve the minimum access time, $t_{\text{TRAC}}(\text{min})$, it is necessary to bring $\overline{\text{CAS}}$ low before $t_{\text{TRCD}}(\text{max})$.

Write

The KM4164B can perform early write, late write and read-modify-write cycles. The difference between these cycles is in the state of data-out and is determined by the timing relationship between $\overline{\text{W}}$ and $\overline{\text{CAS}}$. In any type of write cycle, Data-in must be valid at or before the falling edge of $\overline{\text{W}}$ or $\overline{\text{CAS}}$, whichever is later.

Early Write: An early write cycle is performed by bringing $\overline{\text{W}}$ low before $\overline{\text{CAS}}$. The data at the data input pin (D) is written into the addressed memory cell. Throughout the early write cycle the output remains in the Hi-Z state. This cycle is good for common I/O applications because the data-in and data-out pins may be tied together without bus contention.

Read-Modify-Write: In this cycle, valid data from the addressed cell appears at the output before and during the time that data is being written into the same cell location. This cycle is achieved by bringing $\overline{\text{W}}$ low after $\overline{\text{CAS}}$ and meeting the data sheet read-modify-write cycle timing requirements. This cycle requires using a separate I/O to avoid bus contention.

Late Write: If $\overline{\text{W}}$ is brought low after $\overline{\text{CAS}}$, a late write cycle will occur. The late write cycle is very similar to the read-modify-write cycle except that the timing parameters, t_{RWD} and t_{CWD} , are not necessarily met. The state of data-out is indeterminate since the output could be either Hi-Z or contain data depending on the timing conditions. This cycle requires a separate I/O to avoid bus contention.

Data Output

The KM4164B has a three-state output buffers which are controlled by $\overline{\text{CAS}}$ (and $\overline{\text{W}}$ for early write). Whenever $\overline{\text{CAS}}$ is high (V_{IH}), the output is in the high impedance (Hi-Z) state. In any cycle in which valid data appears at the output, the output first remains in the Hi-Z state until the data is valid and then the valid data appears at the output. The valid data remains at the output until $\overline{\text{CAS}}$ returns high. This is true even if a new $\overline{\text{RAS}}$ cycle occurs (as in hidden refresh). Each of the KM4164B operating cycles are listed below after the corresponding output state produced by the cycle.

Valid Output Data: Read, Read-Modify-Write, Hidden Refresh, Page Mode Read, Page Mode Read-Modify-Write.

Hi-Z Output State: Early Write, $\overline{\text{RAS}}$ -only Refresh, Page Mode write, $\overline{\text{CAS}}$ -only cycle.

Indeterminate Output State: Delayed Write

Refresh

The data in the KM4164B is stored on a tiny capacitor within each memory cell. Due to leakage, the data will leak off after a period of time. To maintain data integrity it is necessary to refresh each of the rows every 2 ms. There are several ways to accomplish this.

$\overline{\text{RAS}}$ -Only Refresh: This is the most common method for performing refresh. It is performed by strobing in a row address with $\overline{\text{RAS}}$ while $\overline{\text{CAS}}$ remains high.

Hidden Refresh: A hidden refresh cycle may be performed while maintaining the latest valid data at the output by extending the $\overline{\text{CAS}}$ active time and strobing in a refresh row address with $\overline{\text{RAS}}$.

Other Refresh Methods: It is also possible to refresh the KM4164B by using read, write or read-modify-write cycles. Whenever a row is accessed, all the cells in that row are automatically refreshed. There are certain applications in which it might be advantageous to perform refresh in this manner but in general $\overline{\text{RAS}}$ -only refresh is the preferred method.

Page Mode

Page mode memory cycles provide faster access and lower power dissipation than normal memory cycles. In page mode, it is possible to perform read, write or read-modify-write cycles. As long as the applicable timing requirements are observed it is possible to mix these cycles in any order. A page mode cycle begins with a normal cycle. While $\overline{\text{RAS}}$ is kept low to maintain the row address, $\overline{\text{CAS}}$ is cycled to strobe in additional column addresses. This eliminates the time required to set up and strobe sequential row addresses for the same page.

Power-up

If $\overline{\text{RAS}} = V_{\text{SS}}$ during power-up the KM4164B might begin an active cycle. This condition results in higher than necessary current demands from the power supply during power-up. It is recommended that $\overline{\text{RAS}}$ and $\overline{\text{CAS}}$ track with V_{CC} during power-up or be held at a valid V_{IH} in order to minimize the power-up current.

An initial pause of 100 μ sec is required after power-up followed by 8 initialized cycles before proper device

DEVICE OPERATION (Continued)

operation is assured. Eight initialization cycles are also required after any 2 ms period in which there are no RAS cycles. An initialization cycle is any cycle in which RAS is cycled.

Termination

The lines from the TTL driver circuits to the KM4164B inputs act like unterminated transmission lines resulting in significant positive and negative overshoots at the inputs. To minimize overshoot it is advisable to terminate the input lines and to keep them as short as possible. Although either series or parallel termination may be used, series termination is generally recommended since it is simple and draws no additional power. It consists of a resistor in series with the input line placed close to the KM4164B input pin. The optimum value depends on the board layout. It must be determined experimentally and is usually in the range of 20 to 40 ohms.

Board Layout

It is important to lay out the power and ground lines on memory boards in such a way that switching transient effects are minimized. The recommended methods are gridded power and ground lines or separate power and ground planes. The power and ground lines act like transmission lines to the high frequency transients generated by DRAMS. The impedance is minimized if all the power supply traces to all the DRAMS run both horizontally and vertically and are connected at each intersection or better yet if power and ground planes are used.

Address and control lines should be as short as possible to avoid skew. In boards with many DRAMS these lines should fan out from a central point like a fork or comb rather than being connected in a serpentine pattern. Also the control logic should be centrally located on large memory boards to facilitate the shortest possible address and control lines to all the DRAMS.

Decoupling

The importance of proper decoupling cannot be over emphasized. Excessive transient noise or voltage droop on the V_{CC} line can cause loss of data integrity (soft errors). The total combined voltage changes over time in the V_{CC} to V_{SS} voltage (measured at the device pins) should not exceed 500mV.

A high frequency 0.1 μ F ceramic decoupling capacitor should be connected between the V_{CC} and ground pins of each KM4164B using the shortest possible traces. These capacitors act as a low impedance shunt for the high frequency switching transients generated by the KM4164B and they supply much of the current used by the KM4164B during cycling.

In addition, a large tantalum capacitor with a value of 47 μ F to 100 μ F should be used for bulk decoupling to recharge the 0.1 μ F capacitors between cycles, thereby reducing power line droop. The bulk decoupling capacitor should be placed near the point where the power traces meet the power grid or power plane. Even better results may be achieved by distributing more than one tantalum capacitor throughout the memory array.

PACKAGE DIMENSIONS

16-LEAD PLASTIC DUAL IN-LINE PACKAGE

Units: Inches (millimeters)

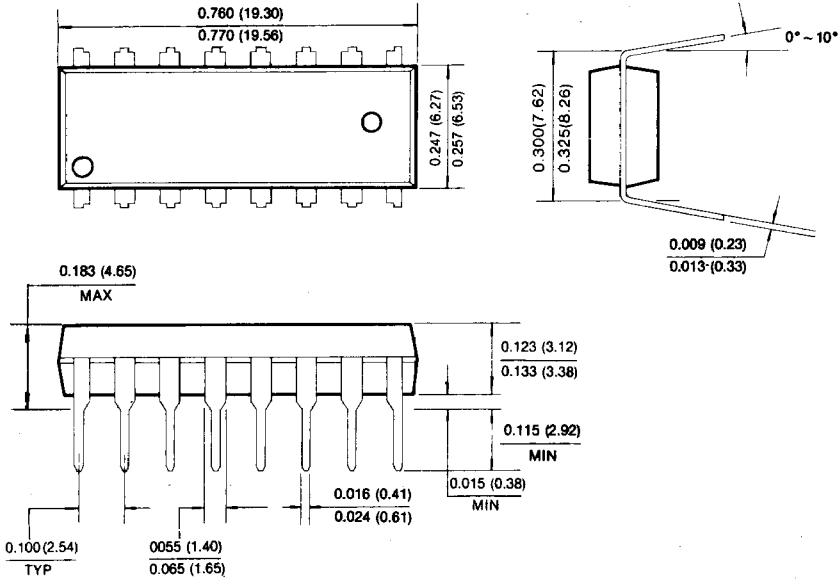

2